

NEATstik®

Neutrophil Elastase Airways Test

For the Detection of Active Neutrophil Elastase

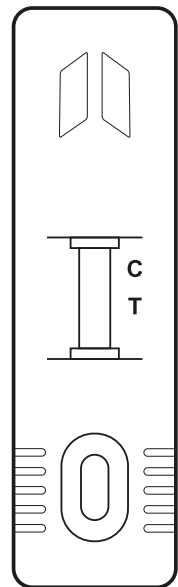

Instructions for use

Catalogue Number – PA004-1 (single kit) and PA004-10 (10 kits)

IFU002 vs 1.0 – 31 Aug 2017



3. PRINCIPLE OF THE TEST

NEATstik® utilises ProteaseTag® technology to specifically detect active NE in sputum samples. NEATstik® consists of a lateral flow test strip enclosed within a plastic cassette. The test strip comprises of a membrane and pads on a solid support with applied CONJUGATE and two reaction lines: a TEST (T) line and a CONTROL (C) line. The conjugate is a mixture of a ProteaseTag® (designed to specifically interact with active NE) and coloured gold particles. The TEST (T) line consists of an antibody which can detect NE and the CONTROL (C) line can detect the conjugate.

After sample dilution, a small volume is added to the sample port on NEATstik® to begin the testing process. The diluted sample travels along the test strip and interacts with the conjugate. The ProteaseTag® in the conjugate will bind to active NE present in the sample, travel up the test strip and bind to the TEST (T) line. Excess conjugate will bind to the CONTROL (C) line.

The appearance of the TEST line confirms the presence of active NE in the sample above the pre-set threshold.

The appearance of the CONTROL line confirms that the test has been performed correctly.

4. KIT COMPONENTS

Each multipack box contains 10 kits.

Each kit contains:

- 1 x NEATstik® lateral flow test in a sealed foil pouch
- 1 x NEATstik® sample dilution buffer (20 mL)
- 1 x Sputum dilution pot
- 1 x Dual bulb pipette
- 1 x Graduated pipette
- 1 x Instruction leaflet

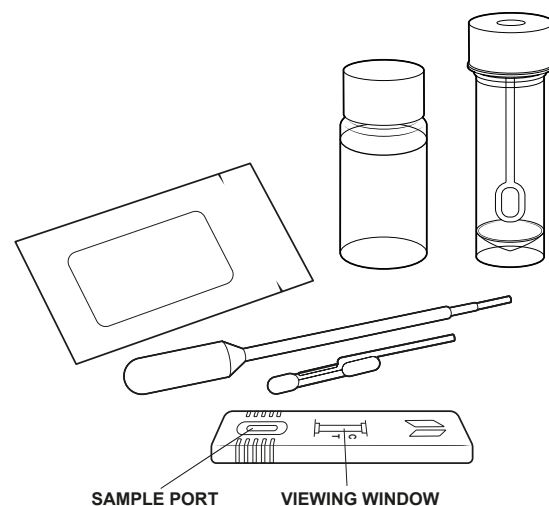

5. MATERIALS REQUIRED BUT NOT PROVIDED

- Sputum collection pot
- Weighing scale or balance
- Stopwatch/timer

6. TESTING PROCEDURE

Collecting the sample

To collect a sample to test, ask the patient to cough up sputum (not saliva) into a sputum collection pot (not provided). It is recommended that samples are tested immediately.



Preparing the sample

Sputum samples must be diluted before addition to NEATstik®.

- (1) Place the base of the sputum dilution pot on a weighing balance. Tare (zero) the weighing balance.

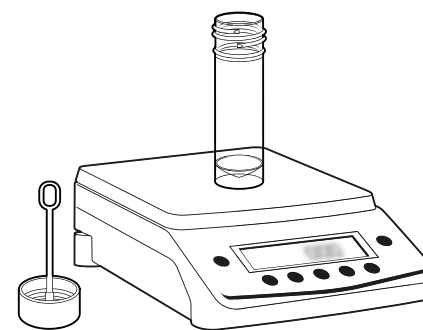

- (2) Keeping the sputum dilution pot on the weighing balance, use the spatula (attached to the lid of the sputum dilution pot) to transfer 1-2 g of sputum from the sputum collection pot into the sputum dilution pot.

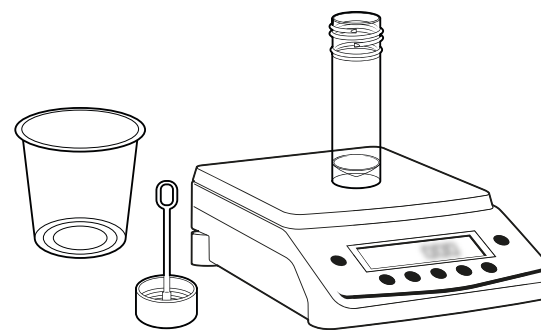

- (3) Note the weight of transferred sputum in grams. The sputum dilution pot should remain on the weighing balance.

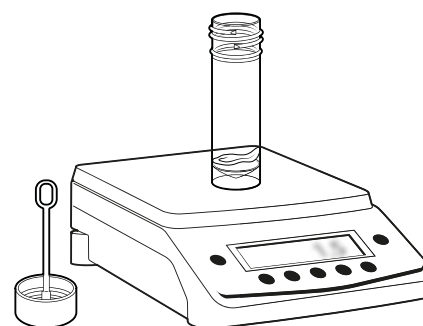

- (4) Calculate the quantity of NEATstik® sample dilution buffer needed to produce a x10 dilution using the following calculation:

$$\begin{aligned} \text{Weight Sputum} &= \dots\dots\dots \text{g} \\ &\times 9 \\ &= \dots\dots\dots \text{g NEATstik}^\circ \\ &\text{sample dilution buffer} \end{aligned}$$

- (5) Tare (zero) the weighing balance.

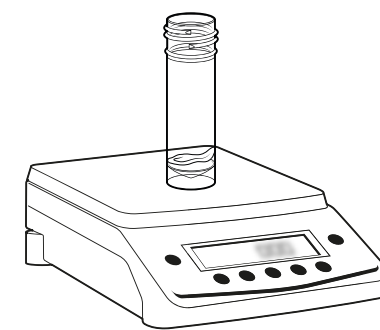

- (6) Using the graduated pipette, transfer NEATstik® sample dilution buffer into the sputum dilution pot up to the weight calculated.

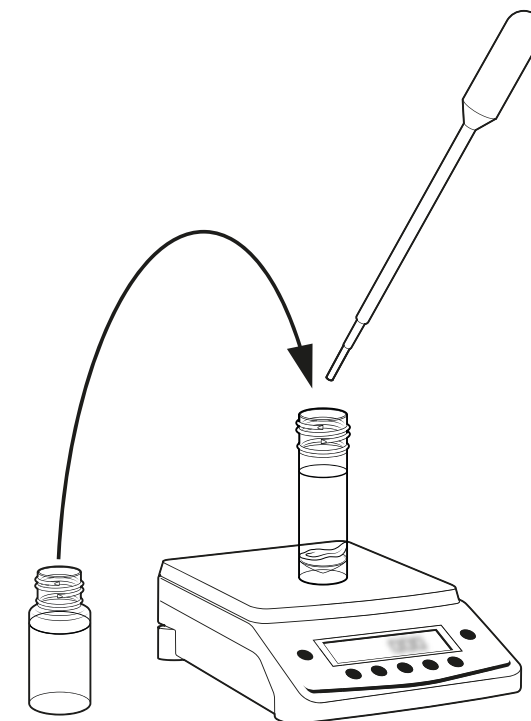

- (7) Place the lid on the sputum dilution pot and ensure it is tight.

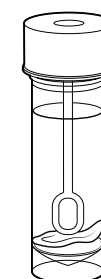

- (8) Mix the sputum with the buffer by turning the sputum dilution pot upside-down 10 times.

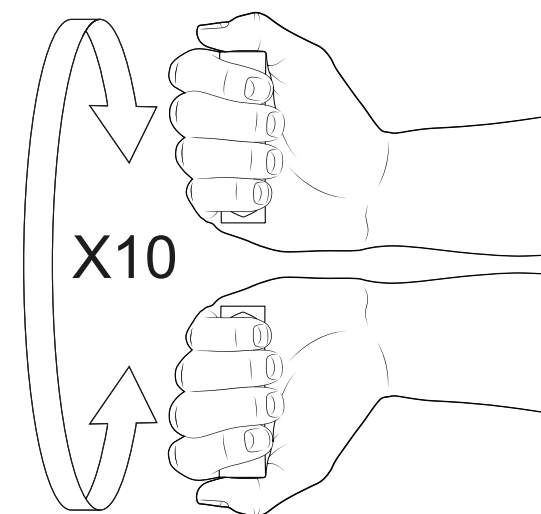

6. TESTING PROCEDURE (cont)

Performing the test

- Remove NEATstik® from the foil packaging and place on a level surface with the viewing window upwards.

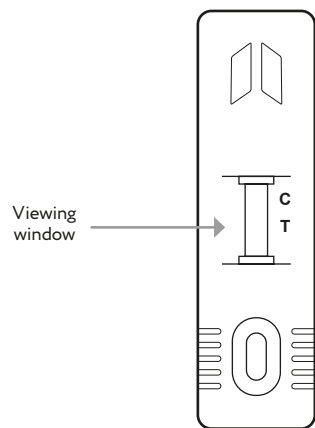

- Remove the lid from the sputum dilution pot.
- Use the dual bulb pipette to draw up a sample of the diluted sputum. Try to ensure solution only – no ‘lumps’ of sputum.

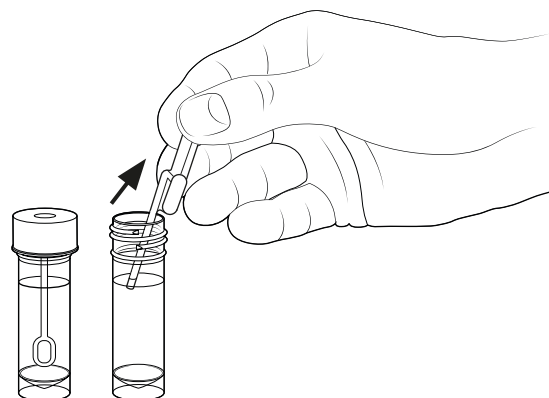

- Apply the sample to the oval shaped sample port on NEATstik®.

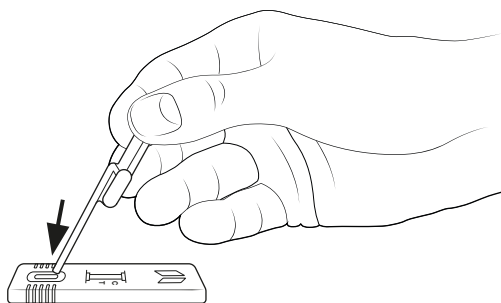

- Wait for 10 minutes (use a timer) before reading the result.

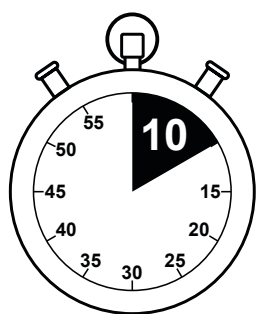

Reading the result and Quality Control

If the test has been performed successfully, the CONTROL (C) line will be visible as a red line (colour intensity may vary). If the CONTROL (C) line is not visible, the results are invalid and the test should be repeated with a new sample and a fresh test kit.

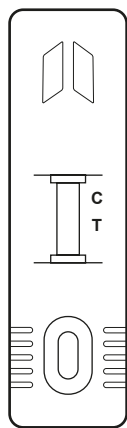

If the TEST (T) line is visible, this confirms the presence of active NE greater than the pre-set threshold, in the sputum sample.

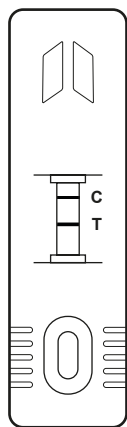

If the TEST (T) line is not visible, any active NE present in the sputum sample does not exceed the pre-set threshold.

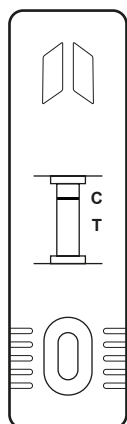

7. PERFORMANCE CHARACTERISTICS

The performance of NEATstik® test was assessed using 58 frozen sputum samples. Active NE was quantified using a ProteaseTag® Active NE Immunoassay (ProAxis Ltd).

- 42 samples had sputum NE concentrations <8 µg/mL = negative
- 16 samples had sputum NE concentrations >8 µg/mL = positive

The test gave a positive result for 16 of the 16 sputum samples with NE quantified above 8 µg/mL (100% sensitivity), and a negative result for 36 of the 42 sputum samples with NE quantified below 8 µg/mL (86% specificity).

8. LIMITATIONS OF USE

- For use with diluted sputum samples only
- For accurate results, please follow the instructions provided
- NEATstik® results must be evaluated in conjunction with other clinical and patient data available to the healthcare professional.
- NEATstik® does not quantify active NE in sputum samples.

9. QUANTIFYING ACTIVE NEUTROPHIL ELASTASE

To measure the concentration of active NE in a sputum sample, use of ProteaseTag® Active Neutrophil Elastase Immunoassay is recommended (available from ProAxis Ltd).

10. TROUBLESHOOTING

The CONTROL (C) line does not appear

The test is invalid. Repeat with new kit.

Some of the test kit components are damaged

If any of the test kit is damaged or missing please contact ProAxis Ltd on +44 (0) 2890 730 445 or info@proaxis.com

11. WARNINGS AND PRECAUTIONS

- Do not use components past their expiry dates
- Do not mix components from different kits lots
- The test is for single use only. Do not reuse
- Suitable protective clothing should be worn when handling sputum samples and while performing the test.

12. STORAGE

Store the kit at room temperature.

Each test kit may be used until the expiration date printed on the label if it remains in original packaging under recommended storage conditions.

NEATstik® lateral flow test should be used immediately after removal from the sealed pouch.

NEATstik® sample dilution buffer should be used immediately after bottle opening.

13. DISPOSAL

Sputum samples and used test components are potentially biohazardous. Dispose of used test kits and sputum samples appropriately in line with local clinical waste guidelines.

14. REFERENCES

- Pham, C. (2008) *International Journal of Biochemistry & Cell Biology*, 40 (6-7), 1317-1333.
- Sandhaus, R. & Turino, G. (2013) *COPD*, 10(S1):60–63.
- Sagel, S. et al (2012) *American Journal of Respiratory and Critical Care Medicine*, 186 (9): 857-865
- Mayer-Hamblett, N. et al (2007) *American Journal of Respiratory and Critical Care Medicine*, 175: 822-828
- Chalmers, J.D. et al (2016) *American Journal of Respiratory and Critical Care Medicine* 195: 1384–1393.

SYMBOLS USED

	EC Declaration of Conformity
	In Vitro Diagnostic Device
	Catalogue Number
	Lot Number
	Consult Instructions
	Manufactured By
	Expiry Date
	Storage Temperature Limitations
	Single Use Only DO NOT Re-use



ProAxis Ltd
Unit 1B
Concourse Building 3
Catalyst Inc
Queen's Road
Titanic Quarter
Belfast BT3 9DT

+44 (0)28 9073 0444
order@proaxis.com
[twitter@proaxis](https://twitter.com/proaxis)

proaxis.com